



Horizontal Cavity Trays

Inter-loc system (new build & existing walls)

Timloc offers two ranges of pre-formed horizontal cavity trays for use in a variety of situations.

For example:

- At the abutment of a flat roof with a cavity wall
- At the abutment of a lean-to roof with a cavity wall
- Over airbricks, ducts, meter boxes etc.

A pre-formed horizontal cavity tray that features an interlocking system with integral stopend to eliminate tape jointing. The tray builds to brick bonding lengths for ease of use and is available in two or four brick lengths. The Inter-loc tray is suitable for use in both new build and remedial situations.

The one tray type covers cavity widths from 50mm to 100mm. A full range of accessories is available for this system.

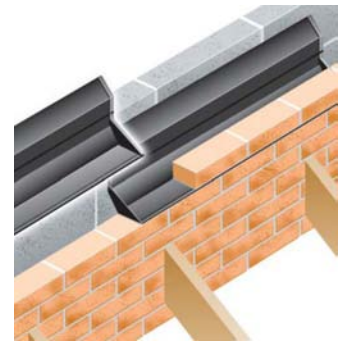
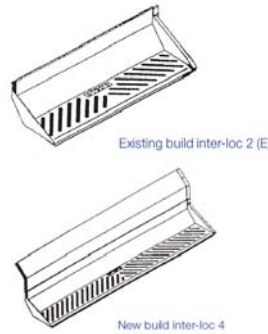

Advantages

- Easy and fast building-in with brickwork sized units .
- Adjoining lengths interlock
- Adjustable upstand ensures cavity width compatibility .
- Traditional or timber frame construction
- Unobstructed cavity compartment area
- Establishes consistent build quality detail



Cavity Weep Vents

Cavity Wall - Tunnel Weep Vents

The Building Regulations NHBC and British Standards require the use of weep holes to allow water to be discharged from the cavity.

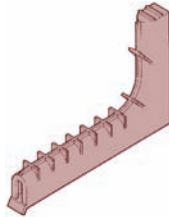

Vent Size

100 x 10 x 65mm

Bluebay Concealed Weep Vents

The triangular design of this weep vent combines a high flow capacity with a small discharge point, making it virtually invisible in finished brickwork.

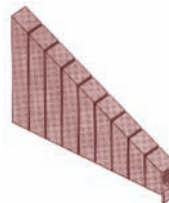

Vent Size

100 x 10 x 65mm

Cavity Wall Weep Vents

Vent Size

10 x 65 x 100mm
10 x 75 x 150mm
10 x 75 x 300mm
10 x 75 x 100mm
10 x 75 x 250mm



Underfloor & Through Wall Venting

High performance airbrick

The high performance ventilator may be used instead of a conventional airbrick.

It is available with a range of attachments:-

Cranked Sleeve type TAV, Vertical Extension Sleeves, Straight Sleeves, Rectangular to Round Converter

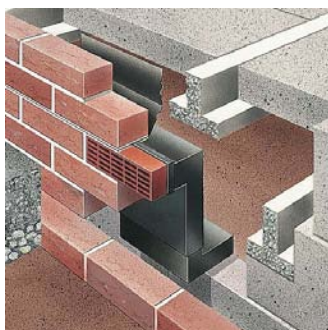

Air Brick Size

69 x 215 x 60mm

Available in a range of colours

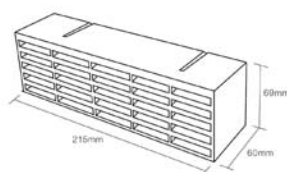

Underfloor & Through Wall Vents

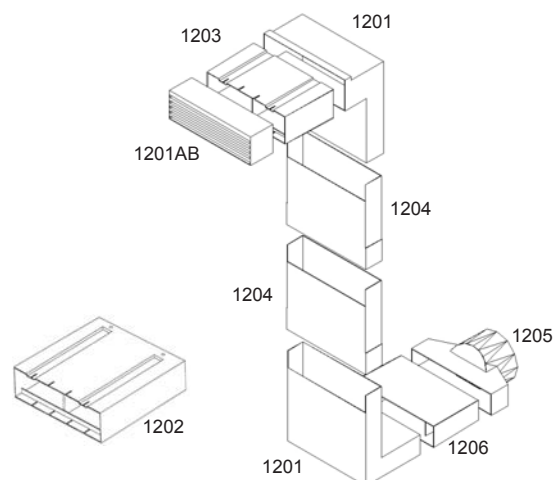

Description	Code
Telescopic Under Floor Vent	1201
Cavity Sleeve	1202
Horizontal Front Extension	1203
Vertical Extension Piece	1204
Duct Adapter	1205
Horizontal Rear Extension	1206